



DATREND
Systems Inc.

Infutest *Sola*

Infusion Pump Analyzer

Operating Manual

Infutest *Solo*

Infusion Pump Analyzer

Operating Manual

© 2004-2014 Datrend Systems Inc.
#130 - 4020 Viking Way
Richmond, BC • CANADA. • V6V 2L4
Tel 604.291.7747 or 800.667.6557 • Fax 604.294.2355
e-mail customerservice@datrend.com



Revision	Revision History Description	Date
E	Clarify Warranty Update Address	2012-Aug-30
F	Update max flow rate. Change Corporate Address.	2014-May-13

Copyright

Datrend Systems Inc. (“Datrend”) agrees to a limited copyright release that allows you to reproduce manuals and other printed materials for use in service training programs and other technical publications. If you would like other reproductions or distributions, submit a written request to Datrend.

Unpacking and Inspection

Follow standard receiving practices upon receipt of the instrument. Check the shipping carton for damage. If damage is found, stop unpacking the instrument. Notify the freight carrier and ask for an agent to be present while the instrument is unpacked. There are no special unpacking instructions, but be careful not to damage the instrument when unpacking it. Inspect the instrument for physical damage such as bent or broken parts, dents, or scratches.

Claims

Our routine method of shipment is via common carrier. Upon delivery, if physical damage is found, retain all packing materials in their original condition and contact the carrier immediately to file a claim.

If the instrument is delivered in good physical condition but does not operate within specifications, or if there are any other problems not caused by shipping damage, please contact your local sales representative or Datrend immediately.

Standard Terms and Conditions

Refunds & Credits

Please note only serialized products (products labelled with a distinct serial number) and accessories are eligible for partial refund and/or credit. Non-serialized parts and accessory items (cables, carrying cases, auxiliary modules, etc.) are not eligible for return or refund. In order to receive a partial refund/credit, the product must not have been damaged, and must be returned complete (meaning all manuals, cables, accessories, etc.) within 90 days of original purchase and in “as new” and resalable condition. The *Return Procedure* must be followed.

Return Procedure

Every product returned for refund/credit must be accompanied by a Return Material Authorization (RMA) number, obtained from Datrend Customer Service. All items being returned must be sent prepaid (freight, duty, brokerage, and taxes) to our factory location.

Restocking Charges

Products returned within 30 days of original purchase are subject to a minimum restocking fee of 15%. Products returned in excess of 30 days after purchase, but prior to 90 days, are subject to a minimum restocking fee of 20%. Additional charges for damage and/or missing parts and accessories will be applied to all returns. Products which are not in “as new” and resalable condition, are not eligible for credit return and will be returned to the customer at their expense.

Certification

This instrument was thoroughly tested and inspected and found to meet Datrend's manufacturing specifications when it was shipped from the factory. Calibration measurements are traceable to the National Research Council of Canada (NRC) and/or the National Institute of Standards and Technology (NIST). Devices for which there are no NRC/NIST calibration standards are measured against in-house performance standards using accepted test procedures.

Warranty

Warranty and Product Support

Datrend Systems Inc. ("DSI") warrants this instrument to be free from defects in materials and workmanship under normal use and service for one (1) year from the date of original purchase. This warranty will be automatically extended on a yearly basis, to a **maximum of five (5) years** from the date of original purchase, provided that calibration is performed on an **annual** basis by a Datrend Authorized Service Center. During the warranty period DSI will, at our option, either repair or replace defects in materials and workmanship at no charge; provided the product is returned (shipping, duty, brokerage and taxes prepaid) to DSI. Any and all transportation charges incurred are the responsibility of the purchaser and are not included within this warranty. This warranty extends only to the original purchaser and does not cover damage from abuse, neglect, accident or misuse or as the result of service or modification by other than DSI. **IN NO EVENT SHALL DATREND SYSTEMS INC. BE LIABLE FOR CONSEQUENTIAL DAMAGES.**

This warranty is subject to the following limitations:

- Occluder Valve: 1 year limited warranty
- Pressure Transducer: 1 year limited warranty
- Battery Pack: 1 year limited warranty
- Standard Accessories: 90 day limited warranty
- Re-calibration of the instrument, which has a recommended annual calibration frequency, is not covered under the warranty.

No warranty shall apply when damage is caused by any of the following:

- Introduction of fluids not specified in the instruction manual,
- Application of excessive pressure or vacuum/suction to the device inputs,
- Failure to rinse or clear the fluid flow path as instructed in the manual,
- Power failure, surges, or spikes,
- Damage in transit or when moving the instrument,
- Improper power supply such as low voltage, incorrect voltage, defective wiring or inadequate fuses,
- Accident, alteration, abuse or misuse of the instrument,
- Fire, water damage, theft, war, riot, hostility, acts of God, such as hurricanes, floods, etc.

Only serialized products (those items bearing a distinct serial number tag) and their accessory items are covered under this warranty. **PHYSICAL DAMAGE CAUSED BY MISUSE OR PHYSICAL ABUSE IS NOT COVERED UNDER THE WARRANTY.** Items such as cables and non-serialized modules are not covered under this warranty.

This warranty gives you specific legal rights and you may have other rights, which vary from province to province, state to state, or country to country. This warranty is limited to repairing the instrument to DSI's specifications.

When you return an instrument to DSI for service, repair or calibration, we recommend shipment using the original shipping foam and container. If the original packing materials are not available, we recommend the following guide for repackaging:

- Use a double-walled carton of sufficient strength for the weight being shipped.
- Use heavy paper or cardboard to protect all instrument surfaces. Use nonabrasive material around all projecting parts.
- Use at least four inches of tightly packed, industrial-approved, shock-absorbent material all around the instrument.

DSI will not be responsible for lost shipments or instruments received in damaged condition due to improper packaging or handling. All warranty claim shipments must be made on a prepaid basis (freight, duty, brokerage, and taxes). No returns will be accepted without a Return Materials Authorization ("RMA) number. Please contact Datrend (see Appendix C) to obtain an RMA number and receive help with shipping/customs documentation.

Warranty Disclaimer

Should you elect to have your instrument serviced and/or calibrated by someone other than Datrend Systems, please be advised that the original warranty covering your product becomes void when the tamper-resistant Quality Seal is removed or broken without proper factory authorization. We strongly recommend, therefore, that you send your instrument to Datrend Systems for service and calibration, especially during the original warranty period. In all cases, breaking the tamper-resistant Quality Seal should be avoided at all cost, as this seal is the key to your original instrument warranty. In the event that the seal must be broken to gain internal access to the instrument (e.g., in the case of a customer-installed firmware upgrade), you must first contact Datrend Systems (see Appendix C). You will be required to provide us with the serial number for your instrument as well as a valid reason for breaking the Quality Seal. You should break this seal only after you have received factory authorization. Do not break the Quality Seal before you have contacted us! Following these steps will help ensure that you will retain the original warranty on your instrument without interruption.

WARNING

Unauthorized user modifications or application beyond the published specifications may result in electrical shock hazards or improper operation. Datrend will not be responsible for any injuries sustained due to unauthorized equipment modifications.

DATREND DISCLAIMS ALL OTHER WARRANTIES, EXPRESSED OR IMPLIED, INCLUDING ANY WARRANTY OF MERCHANTABILITY OR FITNESS FOR A PARTICULAR PURPOSE OR APPLICATION.

<p>THIS PRODUCT CONTAINS NO USER-SERVICEABLE COMPONENTS. UNAUTHORIZED REMOVAL OF THE INSTRUMENT COVER SHALL VOID THIS AND ALL OTHER EXPRESSED OR IMPLIED WARRANTIES.</p>

Windows 95, Windows 98, Windows 2000, Windows XP, and Visual Basic are trademarks or registered trademarks of Microsoft Corp.

Fluke® is a registered trademark of Fluke Corporation

Jet Dry® is a registered trademark of Reckitt Benckiser plc

Table of Contents

1. SPECIFICATIONS	1
1.1 Flow Test	1
1.2 Occlusion Pressure Test	1
1.3 Auto Test	2
1.4 Non-Volatile Memory	2
1.5 Interface	2
1.6 Accessories	4
2. OVERVIEW	5
2.1 General Description	5
2.2 Controls and Interface Connections	6
2.3 Test Fluids	8
3. SET-UP	11
3.1 Fluid and Power Connections	11
3.2 Priming	13
3.3 Optional Connections	16
3.3.1. RS-232 Port	16
3.3.2. USB Port	18
3.4 Installing <i>DTP Solo</i>	18
3.5 Setting Up a HyperTerminal Connection	20
4. OPERATION	23
4.1 Power-On	23
4.2 User Interface	24
4.2.1. Keypad Operation	24
4.2.2. Barcode Reader Operation	26
4.3 Test Modes	27
4.3.1. Rate+Volume Test	27
4.3.2. Occlusion Pressure Test	27
4.3.3. Auto Test	28
4.4 Test Execution	29
4.4.1. Setting Up and Running a Test	30
4.4.2. Starting a Pressure Test from a Running Flow Test	31
4.4.3. Monitoring a Test in Progress	31
4.4.4. Stopping a Test	32
4.4.5. Viewing a Test Summary	32
4.4.6. Saving Test Results	33
4.5 Option Menu Functions	34
4.5.1. Viewing Test Records	35
4.5.2. Delete a Single Test Record	35
4.5.3. Transferring a Single Test Record to a PC/Printer	36

INFUTEST SOLO OPERATING MANUAL

4.5.4. Transferring Multiple Test Records to a PC/Printer	38
4.5.5. Erasing Memory Contents	40
4.5.6. Packing Memory	40
4.5.7. Setting the Real-Time (RT) Clock	41
4.5.8. Selecting Pressure Units	42
4.5.9. Configuring the Auto Test	42
4.5.10. Editing the Solo ID	43
4.5.11. Checking the Battery Status	44
4.6 Recharging the Battery	44
5. REMOTE CONTROL	45
5.1 General Description	45
5.2 Command Set	46
5.2.1. Run Flow Test	46
5.2.2. Run Pressure Test	46
5.2.3. Stop Test	47
5.2.4. Get Flow Result	47
5.2.5. Get Pressure Result	48
5.2.6. Data Download	48
6. ERROR & WARNING MESSAGES	51
6.1 Low Battery	51
6.2 Dead Battery	52
6.3 Flow Sensor Unprimed	52
6.4 Calibration Fault	53
6.5 Pressure Zero Fault	53
6.6 Port Off-line	54
6.7 Download Application Not Running	54
6.8 Memory Full	55
6.9 Injection Failure	55
6.10 Over-Pressure Alarm	56
APPENDIX A. BACK PRESSURE TESTING	57
APPENDIX B. OPERATIONAL OVERVIEW	59
B.1 General Description	59
B.2 Flow Measurement System	60
B.3 Pressure Measurement System	61
APPENDIX C. CALIBRATION	63
C.1 Annual Calibration	63
C.2 Calibration Verification	64
C.2.1 Pressure Accuracy Verification - Field Test	64
C.2.2 Flow Accuracy Verification - Field Test	64

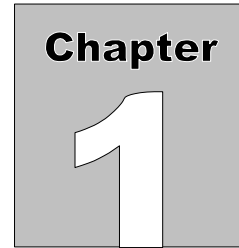

Specifications

This chapter provides performance specifications for the Solo Infusion Device Analyzer.

1. SPECIFICATIONS

1.1 Flow Test

- I. **Flow Measurement**
 - a. Range: 1 - 1200 ml/hr
 - b. Resolution: 0.001 to 1 ml, depending on rate
 - c. Accuracy: $\pm 1\%$ of reading

- II. **Volume Measurement:**
 - a. Range: 0 - 9999 ml
 - b. Resolution: 0.001 ml to 1 ml, depending on volume
 - c. Accuracy: $\pm 1\%$ of reading

- III. **Elapsed Time Measurement:**
 - a. Range: 0 - 100 hours
 - b. Resolution: 1 second
 - c. Accuracy: +0, -1 second
 - d. Format: HH:MM:SS (hours, minutes, seconds)

1.2 Occlusion Pressure Test

- I. **Pressure Measurement:**
 - a. Range: 0 - 2586 mmHg (0 - 50 psi)
 - b. Resolution: 1 mmHg
 - c. Accuracy: $\pm 1\%$ of reading, ± 5 mmHg

INFUTEST SOLO OPERATING MANUAL

II. Elapsed Time Measurement:

- a. Range: 0 - 100 minutes
- b. Resolution: 1 second
- c. Accuracy: +0, -1 second
- d. Format: MM:SS (minutes, seconds)

1.3 Auto Test

I. Infusion Timer

- a. Range: 0 - 9999 seconds
- b. Resolution: 1 second
- c. Accuracy: +0, -1 second

II. Occlusion Timer

- a. Presets: OFF, 1, 2, 3, 5, 10, 20 min
- b. Accuracy: +0, -1 second

1.4 Non-Volatile Memory

I. Capacity:

123 Test Records

II. Record Content:

Pump ID (Control Number)
Test Date (DD MMM YYYY)
Test Time (HH:MM)
Average Rate (ml/h)
Infused Volume (ml)
Peak Occlusion Pressure (mmHg, psi, kpa, bar)
Time of Peak Pressure (MM:SS)

1.5 Interface

I. User Interface:

20-character by 2-line LCD
12-button membrane-type keypad
LCD contrast control

INFUTEST SOLO OPERATING MANUAL

II. Fluid interface

- a. Input: Delrin twistlock, self-sealing
- b. Output: Delrin twistlock

III. USB Port

- a. Connector: Type "B"
- b. Protocol: USB 1.1 or USB 2.0 compatible
- c. Data Rate: 64 bytes per millisecond

IV. RS-232 Port

- a. Connector: DB9 male
- b. Protocol: RS-232C; bidirectional; CTS handshaking;
9600 baud, 8 data bits, no parity bit, 1 stop bit

V. Power Supply:

Internal 12V NiMH, operation time (approx) 30 hours.

VI. Charger:

Universal 100-240 VAC to 18VDC c/w adapter clip

Adapter clips available for North America, Europe, UK, Australia, and China

VII. Environment:

15°C to 40°C
10% to 80% RH
Indoor Use Only
Category I
Pollution Degree 2
Altitude <2000m

VIII. Dimensions:

8.5" W x 6" D x 10" H
22 cm W x 15 cm D x 26 cm H

IX. Weight:

Unit and AC Adapter 5.0 lbs.
2.3 kg

1.6 Accessories

I. Standard Accessories:

Universal AC Adapter, P/N 3000-400

Adapter Blades for AC Adapter:

- North America, P/N 3000-401, or
- Europe, P/N 3000-402, or
- UK, P/N 3000-403, or
- Australia / China, P/N 3000-404

Input/Output tubing set, P/N 7300-012

Flushing syringe (60cc), P/N 7006-006

USB cable (A-B Male), P/N 3140-403

Data Transfer Program (***DTP Solo***) for Windows 98/2000/XP, on CD-ROM P/N 6950-002

II. Optional Accessories:

Operating Manual, P/N 6100-400

Computer interface cable (RS-232), DB9F - DB9F, P/N 3140-400

Computer interface adapter (RS-232), DB9M - DB25F, P/N 3140-401

Printer interface adapter, DB9M - DB25M, P/N 3140-402

Citizen iDP-3110 serial printer, P/N 7050-055

Barcode Pen Reader, P/N 7050-050

Barcode CCD Scanner (RS-232), P/N 7600-051

Barcode CCD Scanner (PS2), P/N 7600-052

Overview

*This chapter gives an overview of the capabilities of **Solo**, the tests performed and test fluid requirements.*

2. OVERVIEW

2.1 General Description

The Infutest **Solo** Infusion Device Analyzer (“**Solo**”) is a portable, automated system for performing flow rate, effused volume and occlusion pressure tests on volumetric medical infusion devices.

Solo provides three test modes for evaluating volumetric accuracy and the occlusion pressure limit of an infusion device. The first test mode uses an internal flow sensor to measure average flow rates in the range 1 ml/hr - 1200 ml/hr, and effused volume to 9999 ml. The second test mode blocks the output of the infusion device and uses an internal pressure sensor to measure the maximum pressure generated by the device under test when its output is occluded. The third test mode is automated and will perform a flow test followed by an optional occlusion pressure test, each test having a duration preset by the user.

Upon completion of a test, **Solo** generates a test result summary that may be saved in the instrument’s non-volatile memory. Saved records may then be viewed directly on the **Solo** LCD, transferred to a PC, or sent to a printer. The non-volatile memory also allows **Solo** to be disconnected from AC power and transported without losing previously acquired test results.

Solo may be powered from its internal NiMH battery or from AC power using the accessory power adapter provided with the unit. The internal battery has sufficient capacity to provide approximately 30 hours of continuous operation.

INFUTEST SOLO OPERATING MANUAL

Solo has two communication ports; RS-232 and USB. The RS-232 Port may be connected to a personal computer, accessory barcode reader, serial printer, or automated test system while the USB Port is intended solely for rapid data transfer to a personal computer using the accessory software application, *DTP Solo*.

To accommodate long-term testing or special testing needs, *Solo* may also be remotely controlled via its RS-232 Port. The remote control command set allows *Solo* to be controlled by a personal computer or other device providing an RS-232 interface.

2.2 Controls and Interface Connections

Figure 1 illustrates the user controls and interfaces of *Solo*. The fluid and electrical interfaces are described in Section 3 of this manual. Keypad operation of *Solo* is described in Section 4.2

INFUTEST SOLO OPERATING MANUAL

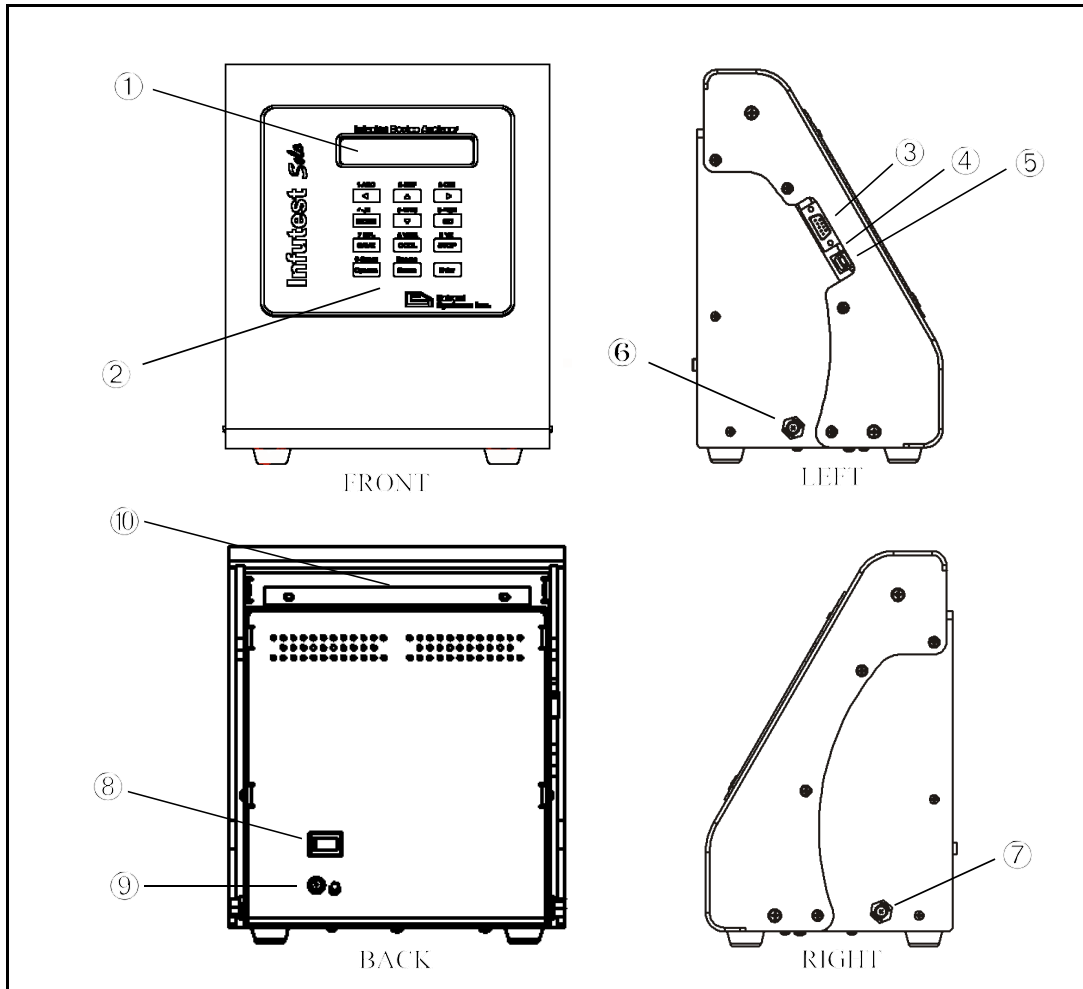

Figure 1: Controls and Interfaces

- | | | | |
|---|-------------------------------------|---|---------------------|
| ① | 2 x 20 Liquid Crystal Display (LCD) | ⑥ | Fluid Input |
| ② | 12-Button Keypad | ⑦ | Fluid Output |
| ③ | RS-232 Port | ⑧ | Power ON/OFF Switch |
| ④ | LCD Contrast Control | ⑨ | DC Power Input |
| ⑤ | USB Port | ⑩ | Carrying Handle |

2.3 Test Fluids

The following test fluids are acceptable for use with *Solo*:

- 1. DISTILLED WATER**
- 2. CLEAN DOMESTIC WATER (i.e. "tap water")**

Common distilled water is the preferred test fluid. If domestic water is used, occasional flushing with distilled water may be required following use, depending on the hardness and quality of the local water. The test fluid should be colourless and should not contain visible particulate matter. An agent for reducing surface tension of the test fluid is not normally required for routine use. However, a wetting agent such as Jet Dry (for dishwashers) may be added if required. In the case of Jet Dry, a concentration of 1.0 ml per litre of test fluid is recommended as a starting point. Wetting agent concentration may have to be varied depending the purity of the test fluid.

IMPORTANT:

THE USE OF SALINE SOLUTION AS A TEST FLUID IS STRONGLY DISCOURAGED, AND WILL VOID THE WARRANTY. IN THE EVENT SALINE SOLUTION IS ACCIDENTALLY USED, *Solo* SHOULD BE FLUSHED WITH DISTILLED WATER.

DO NOT USE DEXTROSE IN WATER (eg. D5W, D25W) OR OTHER VISCOUS TEST FLUIDS WITH *Solo*. USE OF SUCH FLUIDS WILL VOID THE WARRANTY.

If *Solo* is in daily use, **the fluid channel should be kept primed between tests**, provided distilled water or low hardness domestic water is used. If *Solo* is to be stored for several months or transported, fluid should be drained from the unit by forcing air into the fluid channel input with a large syringe. *Solo* should then be carefully blown out from the input to the output using **clean**, dry compressed air.

For the remainder of this manual, the test fluid is assumed to be distilled water or low-hardness domestic water, and is referred to generically as "water".

IMPORTANT:

IV sets which **have** or **may have** come in contact with saline or dextrose or other IV fluids **should not be used** on *Solo*. If an IV set **must** be re-used (i.e. as part of an incident investigation), ensure the set has been flushed out thoroughly with clean water before connecting the set to *Solo*. Most IV fluids contain salts and sugars which can degrade and **potentially ruin** the high-precision flow sensor inside *Solo*.

It is always best to use a new administration set when testing a pump. However, the same administration set may be re-used to test several pumps provided the set is primed **only with distilled or "sterile" water**. Change IV sets per the manufacturer's recommendations to ensure that test results reflect clinical use of the infusion device.

2.4 Cleaning

The following cleaning procedure should be performed on *Solo* once a month if the instrument is used with tap water, or once every three months if *Solo* is used exclusively with distilled water. These recommendations apply to instruments which remain set up and primed at all times. If *Solo* spends most of the time dry and in storage, cleaning should be conducted more frequently, ideally when the dry instrument is first primed during setup. Cleaning after a period of dry storage is the preferred method of "wetting" the fluid system prior to use (see Section 3.2).

In the event of accidental contamination with dextrose or TPN solution, the following procedure should be adequate, provided cleaning is performed immediately following contamination. If cleaning does not appear to improve test results (i.e. flow measurements are persistently erratic, low or nonexistent), contact Datrend Customer Service at 1-800-667-6557 (604-291-7747 outside of North America).

- a. Make 200 ml of cleaning solution by mixing 100 ml of distilled water with 100 ml of "Sudsy Ammonia" household cleaner (e.g. AMEX brand by Colgate-Palmolive Inc.). If "Sudsy Ammonia" is not available in your area, add one-half teaspoon of liquid dish soap (NOT automatic dishwasher detergent!) to the 200 ml of ammonia and water solution.

INFUTEST SOLO OPERATING MANUAL

- b. Fill a disposable 60 ml syringe with the cleaning solution and connect the syringe to the fluid input. Don't use the same syringe you use to prime *Solo* because the cleaning solution will remove the syringe's lubricant.
- c. Discharge the entire syringe into *Solo* at about 2 ml per second. Refill the syringe and then repeat. Under no circumstances should you quickly draw solution back into the syringe as the excessive suction may damage *Solo's* pressure sensor.
- d. Let the cleaning solution sit in *Solo* for 10 to 15 minutes. **DO NOT** leave the cleaning solution in *Solo* any longer than 15 minutes as prolonged exposure to the solution may damage the neoprene seals of the internal valves.
- e. Rinse the fluid channel thoroughly with distilled water to remove all ammonia from the fluid system as described in paragraph “c” above.
- f. If the fluid system has been contaminated with a sticky liquid (e.g. D5W, D25W, TPN solution, etc.), you may need to perform this procedure using undiluted Sudsy Ammonia to clean the flow sensor. In this case, **DO NOT** leave ammonia in *Solo* for more than 10 minutes, and be sure to thoroughly rinse the instrument with distilled water afterwards as described in paragraph “e” above.

Set-up

*This chapter describes the initial set-up of **Solo**, fluid priming, RS-232/USB connections and PC software installation.*

3. SET-UP

3.1 Fluid and Power Connections

Place **Solo** on a stable surface; or mount **Solo** on an IV pole using the optional IV pole mounting bracket (Datrend P/N 7400-653). In either case, **Solo** **MUST** be horizontally level. Insert the plug of the provided AC adapter into the rear panel jack (see **Figure 1**), then plug the adapter into an AC outlet.

IMPORTANT:

YOUR *Solo* HAS BEEN PROVIDED WITH A UNIVERSAL AC ADAPTER (Datrend P/N 3000-400) WHICH CAN ACCEPT AN INPUT VOLTAGE BETWEEN 100 - 264 VAC and 50 - 60 Hz.

THE AC ADAPTER HAS BEEN SUPPLIED WITH ONE OF THE FOLLOWING BLADE SETS PRE-INSTALLED:

North America:	P/N 3000-401
Europe:	P/N 3000-402
United Kingdom:	P/N 3000-403
Australia / China:	P/N 3000-404

USE ONLY THE AC ADAPTER PROVIDED WITH YOUR INSTRUMENT. SUBSTITUTION OR USE OF AN ALTERNATE AC ADAPTER MAY DAMAGE *Solo* AND VOID THE WARRANTY.

INFUTEST SOLO OPERATING MANUAL

- a. Connect the input tubing set (consisting of the IEC recommended 21 gauge flow restrictor, three-way stop cock, and extension set) to the fluid input as shown in **Figure 2**.

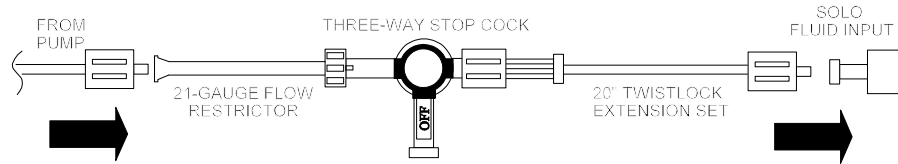

Figure 2: Input tubing connection

- b. Connect the output extension set to the fluid output as shown in **Figure 3**. The fluid output should drain into a collection vessel of appropriate volume ideally located on the bench near **Solo**. A small (250 to 500 ml) beaker will suffice for most test situations.

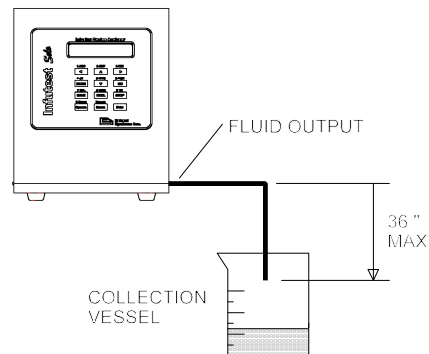

Figure 3: Output tubing connection.

The collection vessel must **NOT** be located more than 36" below the level of the fluid output. A distance greater than 36" will apply a vacuum to **Solo** which could damage the internal pressure sensor, or result in a pressure zero alarm when Solo is powered on.

If your test protocol requires the application of a Back Pressure to oppose the flow from the infusion device under test, refer to the instructions provided in Appendix A.

3.2 Priming

Priming *Solo* involves filling the internal fluid channel with water to remove all air from the fluid pathway. *Figure 4* shows the possible positions of the three-way stop cock connected to the *Solo* fluid input. When the fluid channel is ON, water flows from the infusion device under test into *Solo*. When the fluid channel is OFF, no fluid enters *Solo*. When the fluid channel is in the PRIME/FLUSH position, fluid flows from the 60 cc syringe into *Solo*.

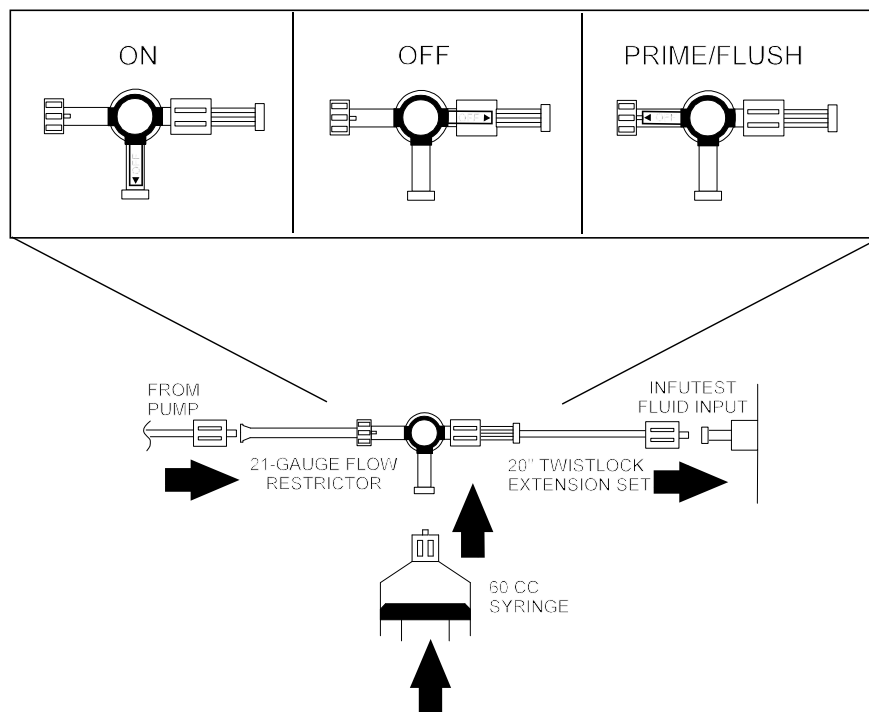

Figure 4: Stop Cock Positions

To prime a *dry* instrument:

- a. Rotate the stop cock to PRIME. Fill the 60 cc syringe, supplied with *Solo*, with 60 cc of **water**. Connect the syringe to the open port on the stop cock and discharge the syringe into the fluid channel. Rotate the stop cock to OFF, and disconnect and refill the syringe. Repeat this priming action at least five times. Eventually, water will begin to drain out the fluid output as air is forced out of the fluid system and reservoir.

INFUTEST SOLO OPERATING MANUAL

- b. Prepare the device under test by loading the device with an administration set and priming the set with water according to the manufacturer's instructions. Connect the primed set to the stop cock and set the stop cock to ON.
- c. If normal saline solution **must** be used as a test fluid (against Datrend's recommended practice), prime as described above. Flush the fluid channel with distilled water immediately following the test. **Under no circumstances should the fluid channel be used or left primed with saline for an extended period of time.**
- d. Unless **Sola** is stored for several months at a time, leave the instrument primed between uses. Following use, flush **Sola** with **distilled water**, set the stop cock to OFF, and store the instrument in an upright position.

IMPORTANT:

It is best to use a new administration set when testing an infusion device, or at least change the set periodically according to the manufacturer's recommendations. Use of IV sets which have or may have been used with saline, dextrose or other IV fluids should be avoided. See Section 2.3, Test Fluids.

IMPORTANT:

After powering-up, **Sola** will attempt to obtain a zero pressure reference. To avoid a "pressure zero" alarm, ensure no pressure is applied at **Sola's** input or output when applying power to the unit. Install the IV set **in** the device under test and leave the device under test on standby while **Sola** performs its self-test routines, to prevent a "pressure zero" alarm.

IMPORTANT:

When testing a syringe pump, always use a **new** disposable syringe. Prelubricate the syringe by drawing on the plunger a few times before loading the syringe with **water** and installing it in the pump.

After priming and connecting the administration set, always **flush the fluid channel** before starting a test. Use a technique similar to that described to prime *Solo* by injecting about **5 cc** of water. This should be sufficient to remove any air bubbles in the fluid channel. *Solo* reminds the user to flush the system via a message displayed on the LCD prior to starting a test.

Solo may be used to test infusion devices immediately after priming the fluid channel as described above. However, after shipping *Solo*, or following a period of dry storage, **optimum results are obtained if the internal flow sensor is first "wetted" before performing tests.**

Solo may be wetted by first priming the instrument, then running a Rate+Volume Test at approximately 500 ml/hr for 10 to 15 minutes (see Section 4.4).

The preferred method of wetting, however, is to flush the instrument with a Sudsy Ammonia solution and distilled water, following the cleaning procedure given in Section 2.4.

Wetting is optional, however, **cleaning** the instrument regularly is recommended, depending on usage. For instruments in daily use with distilled or domestic water, cleaning is recommended monthly. A thorough cleaning is essential if the instrument becomes contaminated with fluids other than water (dextrose, saline, etc.). The procedure for cleaning *Solo* is given in Section 2.4.

3.3 Optional Connections

Solo has RS-232 and USB communication ports located on the instrument's left panel (*Figure 1*). The following sections describe the capabilities and connection requirements for each type of serial port.

3.3.1. RS-232 Port

Solo's RS-232 port can be used to interface to any one of the following peripheral devices.

- | | |
|----------------------------------|--|
| Personal Computer | <ul style="list-style-type: none">• Controls <i>Solo</i> remotely through a COM port using the remote command instruction set.• Downloads test result data (Test Records) stored in <i>Solo's</i> memory. |
| Serial Printer | <ul style="list-style-type: none">• Generates a hard copy printout of Test Records stored in <i>Solo's</i> memory. |
| Barcode Reader or Scanner | <ul style="list-style-type: none">• Enables rapid entry of an equipment control number as scanned from a barcode label on the device under test. |
| Automated Test System | <ul style="list-style-type: none">• Controls <i>Solo</i> using the remote command instruction set. |

The multifunction RS-232 Port is realized through a DB9 male connector whose pinout is shown in *Figure 5*.

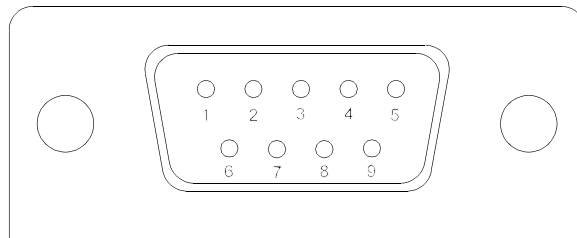

Figure 5: RS-232 Port (front view)

INFUTEST SOLO OPERATING MANUAL

Accessory cables are available to connect the various peripheral devices to *Solo* (Section 1.6).

Connection from *Solo* to a DB9 PC COM port is achieved using a DB9F to DB9F NULL MODEM cable (Datrend P/N 3140-400).

Connection from *Solo* to a DB25 COM port, such as a PC or a Fluke medTester 5000, is achieved using a NULL MODEM cable, noted above, in combination with a DB9M to DB25F adapter (Datrend P/Ns 3140-400 + 3140-401)

Connection from *Solo* to the Citizen serial printer is achieved using a NULL MODEM cable, noted above, in combination with a DB9M to DB25M adapter (Datrend P/Ns 3140-400 + 3140-402)

Alternatively, cables made to the specifications listed in *Table 3-1* may be used to connect *Solo* to the peripheral device. Connectors specified in the table are for the *cables*, and shaded cells in the table indicate no connection.

Table 3-1: RS-232 Interface Cable Specifications

<i>Solo</i> (DB9 F)	PC (DB9 F)	PC/MedTester (DB25 F)	Serial Printer (DB25 M)
2 - RXD	3 - TXD	2 - TXD	
3 - TXD	2 - RXD	3 - RXD	3 - RXD
5 - GND	5 - GND	7 - GND	7 - GND
9 - VCCOUT			
6 - BUSY	4 - DTR	20 - DTR	20 - DTR

IMPORTANT:

NEVER CONNECT THE BARCODE READER TO *Solo* IF THE POWER IS ON! THE BARCODE READER IS POWERED FROM *Solo* AND MAY BE DAMAGED IF “HOT-PLUGGED”. ALWAYS TURN *Solo* OFF BEFORE CONNECTING THE BARCODE READER.

INFUTEST SOLO OPERATING MANUAL

3.3.2. USB Port

The USB Port is provided to rapidly download Test Records from *Solo* to a PC using the accessory software *DTP Solo*. *Solo* may be “hot-plugged” to the PC using a USB cable at any time while the device is running. Once *DTP Solo* successfully detects *Solo*, test data may be sent to the PC from *Solo*.

A USB cable (Datrend P/N 3140-403) is provided with *Solo* as a standard accessory.

3.4 Installing *DTP Solo*

The *Data Transfer Program* for *Solo*, or "*DTP Solo*", is a Windows application for downloading Test Records stored in *Solo* to a PC via USB. Once the Test Records have been transmitted to or retrieved by *DTP Solo*, the Records may be sorted, printed, saved as ASCII text files, or converted to CSV (comma-separated variable) file format.

DTP Solo will run on Windows 98/2000/XP systems, and is provided with *Solo* on CD-ROM. The application may also be downloaded from the Datrend Systems website at www.datrend.com.

To install *DTP Solo* from the CD-ROM, insert the disc into your CD-ROM drive. Windows should automatically launch the application Installation Wizard. Simply follow the instructions presented by the Wizard to complete the installation. If Auto-Run is disabled on your computer, or if you have downloaded *DTP Solo* from the Datrend website, the Installation Wizard will not start up automatically. In this case, search for the file "DTPSoloInstall.exe" on the CD or in the download directory using Windows Explorer, or by clicking on "My Computer" on the desktop. Double-click on DTPSoloInstall.exe to run the installer application.

When installation is complete, connect *Solo* to your PC using the USB cable provided with your instrument. When *Solo* is connected to the PC for the first time, Windows should detect the connection and then automatically launch the New Hardware Wizard which will prompt you for the USB driver. The USB drivers for *Solo* are provided with the *DTP Solo* software. When the Hardware Wizard asks for the files, direct the Hardware Wizard to your CD drive, or to the location where the files were downloaded. The Wizard should then find and install the required driver files.

INFUTEST SOLO OPERATING MANUAL

After installation of *DTP Solo*, there should be a "DTP Solo" icon on your Windows desktop. Double-click the icon to start *DTP Solo*. Once the program recognizes the attached *Solo*, *DTP Solo* will display the message shown in *Figure 6* to indicate the PC is ready to communicate with the instrument:



Figure 6

Click on "OK" to clear the "Device Attached" message. To review complete operating instructions for the *DTP Solo* program, click "About" on the menu bar, then select "Help".

NOTE:

DTP Solo will not detect USB connection of *Solo* if the instrument is busy running an Options Menu function, or is waiting for the user to input a Pump ID at the start of a flow or pressure test.

It is always best to connect the USB Port of *Solo* to the PC while the LCD is displaying the RUN TEST/OPTIONS prompt. This will ensure the instrument is detected by *DTP Solo*, either before or after the program is started.

NOTE:

During installation of the USB drivers, Windows XP users may receive a warning message that the driver has not been "Logo Tested". Please ignore this warning and clear the message by clicking the "OK" button which is displayed.

3.5 Setting Up a HyperTerminal Connection

As described in Section 3.3.1, the RS-232 Port of *Solo* may be connected to the serial communications port (COM port) of a personal computer. A terminal program (i.e., Windows 98/2000/XP HyperTerminal or equivalent) running on the PC may then be used to receive Test Records and save them to a text file. Follow the instructions below to set up HyperTerminal for use with *Solo*.

- a. Open HyperTerminal: In Windows XP, click **Start**, point to **All Programs**, point to **Accessories**, point to **Communications** and click on HyperTerminal.
- b. You will be prompted to enter a name for the HyperTerminal connection and select an icon associated with this new connection. Enter a suitable name, select the desired icon, and click on **OK**. Next time, click on this icon from Explorer or the **Start** menu to avoid having to set up a new connection every time you wish to use HyperTerminal.

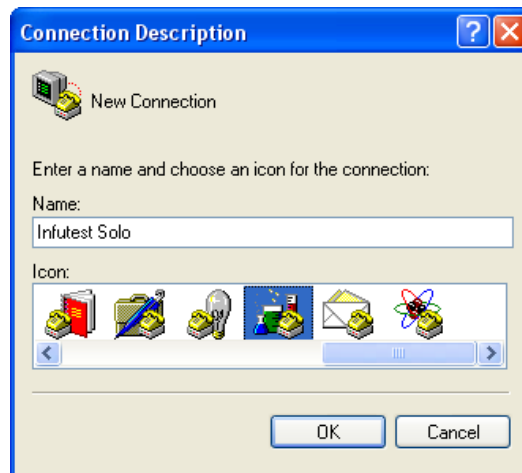

Figure 7

- c. A dialogue box will appear asking which port to connect to. Select the appropriate COM port and click on **OK**.
- d. Another dialogue box appears to configure the port settings. Configure the port settings as shown in *Figure 8* and click on **OK**.

INFUTEST SOLO OPERATING MANUAL

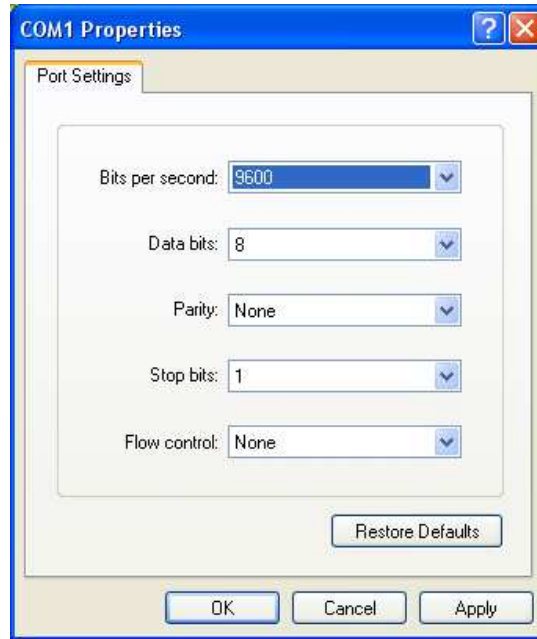

Figure 8

- e. In the HyperTerminal program window, click on **Transfer** in the menu bar and click on **Capture Text** to save all Test Records to a file. In the **File** box, type a descriptive name for the file, and then click **Start**.
- f. HyperTerminal is now ready to receive data sent from *Solo* to the PC. Refer to Sections 4.5.3 and 4.5.4 for details on how to transfer Test Records from *Solo* to a PC.
- g. Once all Test Records have been transferred, stop capturing text. In the **Transfer** menu, point to **Capture Text** and click on **Stop**.

INFUTEST SOLO OPERATING MANUAL

Operation

*This chapter describes the operation of **Solo**, the various test modes, and optional functions.*

4. OPERATION

4.1 Power-On

Turn on **Solo** by switching the rear panel power switch to ON. The LCD will display a power-up screen and **Solo** will perform a built-in self-test to ensure all internal components are functioning properly. If all components pass the initial self-test, the LCD will display the RUN TEST/OPTIONS prompt shown in **Figure 9**. If required, adjust the LCD contrast control on the right panel using a trimpot adjustment tool. The contrast adjustment is positioned between and behind the USB and RS-232 ports (**Figure 1**).



```
RUN TEST:  <Enter>
OPTIONS:   <Options>
```

Figure 9

If an abnormal condition is detected during the built-in self-test, a fault message will appear on the LCD accompanied by an alarm. Refer to Chapter 6 if an alarm condition arises.

The RUN TEST/OPTIONS prompt is the point from which all operations begin. At this prompt, pressing the key on the keypad will proceed to test execution, while pressing the key will access the functions provided in the Options Menu.

4.2 User Interface

Solo has a menu-driven user interface implemented with a 20-character x 2-line liquid crystal display (LCD), and a 12-button membrane-type keypad (*Figure 10*). The keypad can be used to control device operation or to enter alphanumeric data. Alternatively, data entry is also possible using the accessory barcode reader (Datrend P/N 7050-050) or barcode CCD scanner (Datrend P/N 7050-051).

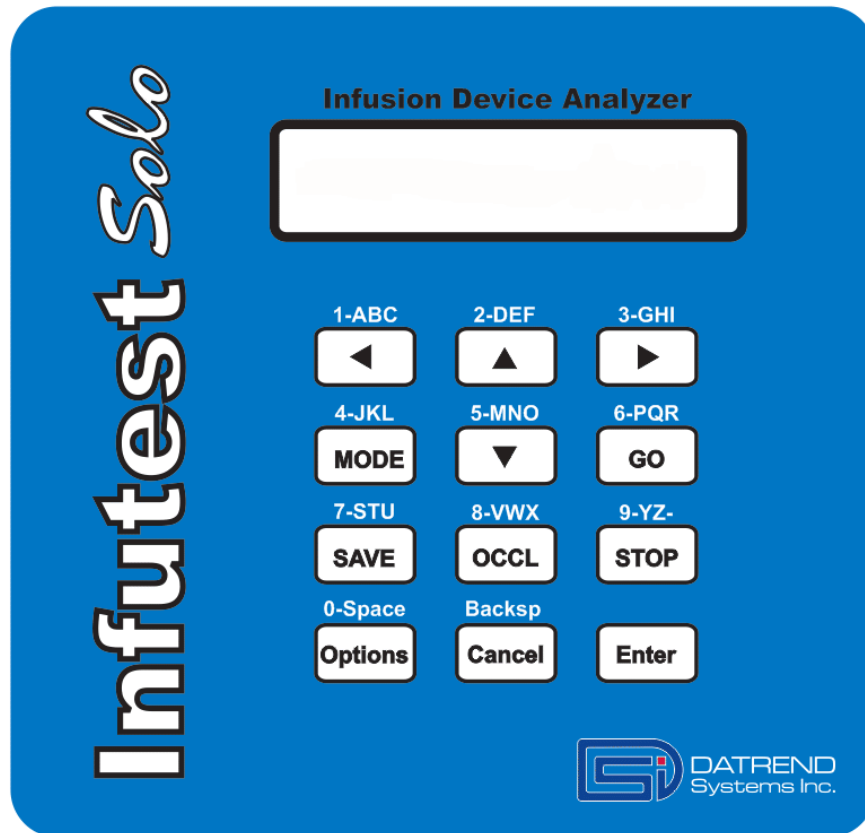















Figure 10

4.2.1. Keypad Operation

With the exception of the  key on the keypad, all keys have both a primary and secondary function. The primary function of each key is written directly on the button itself, and the secondary function is written above the button. The primary functions are associated with instrument operation, while the secondary functions are associated with alphanumeric data entry.

INFUTEST SOLO OPERATING MANUAL

Primary Keypad Functions:

-  Scrolls backward.
-  Scrolls backward, or increments numeric data.
-  Scrolls forward.
-  Scrolls forward, or decrements numeric data.
-  Selects the test mode.
-  Starts the selected test.
-  Saves test results to non-volatile memory.
-  Initiates an Occlusion Pressure Test.
-  Stops the test currently in progress.
-  Displays the Options Menu.
-  Cancels input or aborts the current operation.
-  Accepts the current input or selection.

Secondary Keypad Functions:

Above each key on the keypad appears a numeric digit and three alphabetic characters for data entry purposes. When data entry is required, repeatedly pressing a single key sequentially displays the characters associated with that key at the current cursor position (i.e., 1, A, B, C, 1, A, B...). Pressing a key other than the one initially pressed will enter the displayed character, move the cursor one space to the right, and display the digit associated with the new key. Alternatively, the displayed character is automatically entered after a 2-second inactivity timeout. Pressing the BACKSP key clears the character displayed at the current cursor position and moves the cursor to the left one space, providing a backspace or correction function.

4.2.2. Barcode Reader Operation

An accessory Barcode Reader (Datrend P/N 7050-050) and Barcode CCD Scanner (Datrend P/N 7600-051 or 7600-052) are available to rapidly enter alphanumeric data from a barcode label to identify an infusion device under test (Section 4.4.1), or to enter an ID for *Solo*, uniquely identifying the tester itself within your equipment control system.

Barcode reading devices are connected to the RS-232 Port as described in Section 3.3, and are powered directly from *Solo*. If a barcode reader is attached and data entry is requested from the user, the barcode reader will generate a tone indicating it has been powered on. Scanned data appears on the LCD and is accepted by pressing the key, or cleared by pressing the or BACKSP key on the keypad.

If *Solo* is operating on battery power, you will have 30 seconds to scan a barcode after the reader has been powered on. The 30-second timeout is provided to prevent excessive battery drain as the power consumed by the reader is significant.

IMPORTANT:

NEVER CONNECT A BARCODE READER ACCESSORY TO *Solo* IF THE POWER IS ON! BARCODE READER ACCESSORIES ARE POWERED FROM *Solo* AND MAY BE DAMAGED IF “HOT-PLUGGED” INTO THE *Solo* RS-232 PORT. ALWAYS TURN OFF *Solo* BEFORE CONNECTING A BARCODE READER ACCESSORY.

4.3 Test Modes

Solo provides three test modes to measure volumetric accuracy and the occlusion pressure limit of an infusion device. The next sections describe each test mode in detail.

4.3.1. Rate+Volume Test

The Rate+Volume Test measures average flow rates from 1 to 1200 ml/hr and effused volume up to 9999 ml. The infusion device under test connects to the input tubing set of *Solo* as shown in *Figure 2* of Section 3. Fluid effused from the infusion device enters the fluid input channel, passes through the flow sensor of the instrument and exits via the fluid output channel. While the Rate+Volume Test is in progress, the LCD will display the average flow rate, total effused volume, and the elapsed time since the test was started.

When a Rate+Volume Test is stopped, a test result summary is generated and displayed on the LCD. The test result summary includes the following test information which may be saved (Section 4.4.6) or discarded.

- ▶ Pump ID (control number)
- ▶ Average Flow Rate (ml/hr)
- ▶ Total Effused Volume (ml)
- ▶ Total Elapsed Time (HH:MM:SS)

The Pump ID uniquely identifies the device under test, and is input by the user prior to test execution.

Note: The fluid volume entering *Solo* will not equal that exiting as there is a water reservoir inside the unit which will hold an indeterminate portion of the effused fluid.

4.3.2. Occlusion Pressure Test

The Occlusion Pressure Test measures maximum pressure generated by an infusion device when its output is occluded. The infusion device under test connects to the input tubing set of *Solo* as shown in *Figure 2* of Section 3. Fluid effused from the infusion device enters the fluid input channel, and is blocked by an internal valve. A pressure sensor measures the rising pressure developed against the occlusion, and this instantaneous pressure is displayed on the *Solo*

INFUTEST SOLO OPERATING MANUAL

LCD while the test is in progress. The instantaneous pressure is displayed in units of mmHg and one other user-defined unit (psi, kPa or bar). Refer to Section 4.5.8 for details regarding pressure unit selection.

When an Occlusion Pressure Test is stopped, a test result summary is generated and displayed on the LCD. The test result summary contains the following information which may be saved (Section 4.4.6) or discarded.

- ▶ Pump ID (control number)
- ▶ Maximum measured pressure (mmHg)
- ▶ Maximum measured pressure (psi, kPa or bar)
- ▶ Time at which maximum pressure was generated (MM:SS)

It is also possible to start an Occlusion Pressure Test “on the fly” while a Rate+Volume Test is already in progress. Pressing the  key while a flow test is in progress will automatically terminate the Rate+Volume Test and immediately start an Occlusion Pressure Test. When the Occlusion Pressure Test is terminated by the user, a test result summary is generated and displayed on the LCD. The test summary is a combination of the Rate+Volume Test summary and the Occlusion Pressure Test summary.

***Solo's* pressure sensor can withstand up to 50 PSI of applied pressure. If this pressure limit is exceeded, the Occlusion Pressure Test will terminate automatically to prevent damage to the pressure sensor.**

4.3.3. Auto Test

The Auto Test automatically performs a timed Rate+Volume Test followed by an optional Occlusion Pressure Test. The duration of each test is preset by the user via the “Auto Test Setup” function in the Options Menu. Refer to Section 4.5.9 to configure the Auto Test.

The Auto Test uses an Infusion Timer and Occlusion Timer to set the duration of the Rate+Volume Test and Occlusion Pressure Test respectively. The Infusion Timer may be set to any value in the range 10 - 9999 seconds, whereas the Occlusion Timer value must be chosen from preset values: OFF, 1 minute, 2 minutes, 3 minutes, 5 minutes, 10 minutes, or 20 minutes.

When an Auto Test is stopped, a test result summary is generated and displayed on the LCD. The test result summary includes the following test information which may be saved (Section 4.4.6) or discarded. The occlusion pressure data is omitted if only a flow test is conducted.

INFUTEST SOLO OPERATING MANUAL

- ▶ Pump ID (control number)
- ▶ Average Flow Rate (ml/hr)
- ▶ Total Effused Volume (ml)
- ▶ Total Elapsed Time (HH:MM:SS)
- ▶ Maximum measured pressure (mmHg)
- ▶ Maximum measured pressure (psi, kPa or bar)
- ▶ Time at which maximum pressure was generated (MM:SS)

4.4 Test Execution

The steps below outline how a typical test is conducted on *Solo*.

Test Execution Overview

- Step 1:** Set up a test
 - a) Select a test mode
 - b) Enter a pump ID associated with the device under test
 - c) Flush *Solo*
- Step 2:** Run the test
- Step 3:** Monitor the test in progress
- Step 4:** Stop the test
- Step 5:** View the test result summary
- Step 6:** Save the summary as a Test Record (optional)

To execute a test, connect the infusion device to *Solo* and prime as described in Section 3.2. The following sections detail each of the steps listed above.

4.4.1. Setting Up and Running a Test

- a. Press while viewing the RUN TEST/OPTIONS prompt.
- b. You will be prompted to select a test mode. Select a test mode by scrolling through the three different options using the key, and press to select the displayed test mode.
- c. You will be prompted to enter a Pump ID:



Figure 11

The Pump ID should uniquely identify the device under test, such as an equipment control number or serial number. The maximum number of characters that may be input is limited to 16, and the first character in the ID must not be a blank space. Enter a Pump ID using the keypad or accessory barcode reader and press . Refer to Section 4.2 for keypad and barcode reader operation.

Alternatively, the Pump ID entry may be skipped by pressing with no characters entered. Note however, a Pump ID must be entered before test results may be saved to non-volatile memory in *Solo*.

- d. *Solo* now displays a reminder to flush the system. Always flush the fluid channel before starting any test. Use the technique described in Section 3.2 for priming the fluid channel. Injecting approximately 5 cc of water should be sufficient to purge any air bubbles present.
- e. Once the system is flushed, press and start the infusion pump as directed on the LCD. The selected test is now in progress.

4.4.2. Starting a Pressure Test from a Running Flow Test

While a Rate+Volume Test is in progress, an Occlusion Pressure Test may be initiated by pressing the  key. This will terminate the flow test in progress and immediately start a pressure test. The LCD will change to display the instantaneous pressure, and when the pressure test is complete, a test summary with both the flow and pressure results will be displayed.

4.4.3. Monitoring a Test in Progress

When a Rate+Volume Test is started by the user, *Solo* will wait until fluid flow is detected, and then proceed to take measurements. While *Solo* is detecting initial flow, the display will flash indicating that a test has been started, but an initial measurement has not yet been made.

Once the initial measurement is completed, the LCD will display the average flow rate (**RATE**) on the upper line of the LCD and either the total volume effused (**VOL.**) or the elapsed time since the test was started (**TIME**) in hours, minutes and seconds on the lower line of the LCD as shown in *Figure 12* and *Figure 13*. The LCD will update periodically as new measurement data is obtained (approximately after every 0.15 ml of fluid delivery).



Figure 12



Figure 13

Toggle the lower line of the LCD between volume and time by pressing any of the four arrow keys on the keypad (   ).

INFUTEST SOLO OPERATING MANUAL

Similarly, while an Occlusion Pressure Test is in progress, the LCD will display the instantaneous pressure (**OCCL PR.**) in user-defined units (psi, kPa, or bar) on the upper line of the LCD and either the instantaneous pressure in mmHg or the elapsed time since the test was started (**TIME**) in minutes and seconds on the lower line of the LCD as shown in *Figure 14* and *Figure 15*.



Figure 14



Figure 15

Toggle the lower line of the LCD between pressure and time by pressing any of the four arrow keys on the keypad:  ,  ,  ,  .

4.4.4. Stopping a Test





To stop a test in progress, simply press the  key. The test terminates, and a test result summary will appear on the LCD.



4.4.5. Viewing a Test Summary

After a test has been terminated, a test summary appears on the LCD containing all or some of the following test results depending on the type of test conducted (i.e., flow only, pressure only or flow+pressure).

- ▶ Pump ID (control number)
- ▶ Average Flow Rate (ml/hr)
- ▶ Total Volume Effused (ml)
- ▶ Flow Test Duration (HH:MM:SS)
- ▶ Peak Occlusion Pressure (mmHg)
- ▶ Peak Occlusion Pressure (PSI, kPa, or bar)
- ▶ Time of Peak occlusion pressure (MM:SS)

INFUTEST SOLO OPERATING MANUAL

The LCD will display the test results two lines at a time. Use the arrow keys ( ) to scroll forward and ( ) to scroll backward through the test results.



To save the test summary in the non-volatile memory of *Solo*, proceed to section 4.4.6. To clear the test summary and return to the RUN TEST/ OPTIONS prompt, press  ,  or  .

Once the *Solo* display returns to the RUN TEST/OPTIONS prompt, unsaved test results are not recoverable.

4.4.6. Saving Test Results

Solo can store up to 123 test result summaries in its non-volatile memory. Each test summary is stored as a Test Record and includes a Pump ID, flow and/or pressure data along with a date and time stamp.

To save the test results to memory, press the  key while viewing the test summary (Section 4.4.5). *Solo* will save all results shown in the test result summary along with the current date and time to a record in memory.

Note that in order to save a record, a Pump ID must be entered. If, at the start of the test, a Pump ID was not entered, a prompt will appear after pressing the  key. At this point, enter a Pump ID via the keypad or accessory barcode reader and press  .

After each save operation, *Solo* will display the amount of memory remaining, as shown in *Figure 16*.



Figure 16

If the memory is full when  is pressed, *Solo* will display an error message and the Test Record will not be saved.

4.5 Option Menu Functions

The Options Menu provides the following functions.

- | | |
|--------------------|---|
| 1. VIEW RECORDS | <i>View</i> saved records; <i>Delete</i> single records; <i>Output</i> single records to a PC or printer. |
| 2. OUTPUT RECORDS | Output all or selected Test Records to a PC or printer. |
| 3. ERASE MEMORY | Erase all Test Records stored in non-volatile memory. |
| 4. PACK MEMORY | Compress the non-volatile Test Record memory to eliminate any gaps caused by deleting records. |
| 5. SET CLOCK | Set the real-time clock to the current date and time. |
| 6. AUTO TEST SETUP | Configure the Auto Test. |
| 7. PRESSURE UNITS | Select occlusion pressure units: psi, kPa or bar. |
| 8. EDIT SOLO ID | Edit the ID (control number) of the <i>Solo</i> . |
| 9. BATTERY STATUS | Check the internal battery voltage level. |
| 10. EXIT | Exit the Options Menu and return to the RUN TEST/OPTIONS prompt. |







To access the Options Menu, press the  key while viewing the RUN TEST/OPTIONS prompt. The display appears showing the first menu item as shown in *Figure 17*.



Figure 17

To navigate through the Options Menu, use the arrow keys to scroll forward () and backward ( ). To select a particular menu item, press  with the desired menu item displayed. To return to the RUN TEST/OPTIONS prompt, press . The following sections describe the functions provided in the Options Menu.

4.5.1. Viewing Test Records

- a. Press when viewing the RUN TEST/OPTIONS prompt to enter the Options Menu.
- b. The LCD will display item 1. VIEW RECORDS as shown in *Figure 17*. Press to select this function.
- c. The LCD will show the most recent Test Record along with its Pump ID (*Figure 18*):



Figure 18

Use the up and down arrow keys () to scroll through the different Test Records available for viewing, and use the right and left arrow keys () to scroll through the test data contained in a particular Test Record.

- d. To exit the View Records function and return to the Options Menu, press or .

4.5.2. Delete a Single Test Record

A single Test Record stored in *Solo's* memory may be deleted via the View Records function. Follow the procedure outlined below to permanently delete a Test Record from memory.

- a. Press while viewing the RUN TEST/OPTIONS prompt to enter the Options Menu.
- b. The LCD will display item 1. VIEW RECORDS. Press to select this function.

INFUTEST SOLO OPERATING MANUAL





- c. Select the record to delete using the up and down arrow keys () and press ) and press  .
- d. A prompt appears to either output or delete the selected record. Press the down arrow key to move the selection arrow (➤) to point to DELETE RECORD and press  .





Figure 19

- e. Another prompt appears to confirm deletion:



Figure 20

The up and down arrow keys ( ) will toggle the selection arrow (➤) between NO and YES. Press the down arrow key to move the selection arrow to point to YES and press  . The record will now be permanently deleted from memory, and the display returns to the main Options Menu.

4.5.3. Transferring a Single Test Record to a PC/Printer

A single Test Record may be output from *Solo* using the View Records function. Records may be output via RS-232 to a PC or serial printer, or via USB to a PC running the *DTP Solo* accessory software application. To install *DTP Solo* on your PC, refer to Section 3.4. To transfer Test Records to a PC via RS-232 using *HyperTerminal*, refer to Section 3.5

INFUTEST SOLO OPERATING MANUAL

- a. Connect the PC or printer to *Solo* with the appropriate interface cable and adapter (Section 3.3). If sending Test Records to a PC over USB, run the *DTP Solo* application.
- b. Press while viewing the RUN TEST/OPTIONS prompt to enter the Options Menu.
- c. The LCD will display 1. VIEW RECORDS. Press to select this function.
- d. Select the record to output using the up and down arrow keys () and press .
- e. A prompt will appear to either output or delete the selected record. With the selection arrow (➤) pointing to OUTPUT RECORD (*Figure 21*), press .



Figure 21

- f. Another prompt will appear to either output the selected Test Record via USB or RS-232 (*Figure 22*):

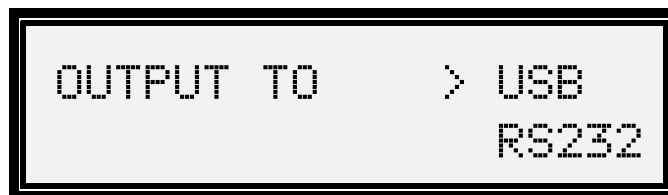

Figure 22

Using the up and down arrow keys (), toggle the selection arrow (➤) between USB and RS-232 to select the desired output port and press .

Note: An attempt to send data out via the RS-232 port when a bar code reader is connected to the RS-232 port will result in a Port Off-line Error as described in Section 6.6. For information on other error messages, refer to Chapter 6.

4.5.4. Transferring Multiple Test Records to a PC/Printer

The Output Records function allows the user to output multiple Test Records from *Solo* via RS-232 to a PC or serial printer, or via USB to a PC running the *DTP Solo* accessory software application. To install *DTP Solo* on your PC, refer to Section 3.4. To transfer Test Records to a PC via RS-232 using HyperTerminal, refer to Section 3.5.

- a. Connect the PC or printer to *Solo* with the appropriate interface cable and adapter (Section 3.3). If sending Test Records to a PC over USB, run the *DTP Solo* application.
- b. Press while viewing the RUN TEST/OPTIONS prompt to enter the Options Menu.
- c. Use the arrow keys to scroll to item 2. OUTPUT RECORDS and press .
- d. A prompt will appear to either output the selected Test Record via USB or RS-232 (*Figure 23*):



Figure 23

Use the up and down arrow keys (), to toggle the selection arrow (➤) between USB and RS-232 to select the desired output port and press .

- e. If USB is chosen, all Test Records will be output to the *DTP Solo* application within a few seconds. If any error messages arise, refer to Chapter 6.
- f. If RS-232 is chosen, another prompt will appear to either output select records, or all records (*Figure 24*):

INFUTEST SOLO OPERATING MANUAL



Figure 24

Use the up and down arrow keys () to toggle the selection arrow (➤) between `SELECT RECORDS` and `ALL RECORDS` and press .

- g. If `ALL RECORDS` was chosen, data transfer begins immediately. If `SELECT RECORDS` was chosen, another prompt appears to select which records to output (*Figure 25*):



Figure 25

Use the up and down arrow keys () to increment and decrement the number of records to output and press . Data transfer will begin immediately. If any error messages arise, refer to Chapter 6.

- h. If Test Records were output via the RS-232 Port, a prompt will appear to clear all memory contents (*Figure 26*):



Figure 26

Use the up and down arrow keys () to move the selection arrow (➤) between `YES` and `NO`. Select `YES` to permanently erase all Test Records in memory or press `NO` to return to the main Options Menu without clearing the memory, and press .

4.5.5. Erasing Memory Contents

Follow the instructions below to erase all Test Records stored in the non-volatile memory. **Note: Executing this function will permanently delete all Test Records.**

- a. Press while viewing the RUN TEST/OPTIONS prompt to enter the Options Menu.
- b. Use the arrow keys to scroll to item 3. ERASE MEMORY and press .
- c. A prompt appears asking for confirmation to clear the memory. Use the up and down arrow keys to toggle the selection arrow (>) between YES and NO. To abort the Erase Memory operation, move selection arrow to NO and press . To continue with the Erase Memory function, move the selection arrow to YES and press .
- d. Another prompt appears again asking for confirmation to clear the memory since this operation is permanent (*Figure 27*):



Figure 27

Select either YES or NO using the up and down arrow keys () and press . The Erase Memory function then executes, and a completion message is displayed on the LCD when all the memory has been cleared. The display will return to the main Options Menu automatically.

4.5.6. Packing Memory

Test Records are stored in *Solo's* non-volatile memory. When a single Test Record is deleted following the procedure described in Section 4.5.2, a gap is left in memory where the record was previously stored. The Pack Memory function eliminates all such gaps in memory to free space for additional Test Records. The following instructions will execute the Pack Memory function:

INFUTEST SOLO OPERATING MANUAL

- a. Press while viewing the RUN TEST/OPTIONS prompt to enter the Options Menu.
- b. Use the arrow keys to scroll to item 4. `PACK MEMORY` and press .
- c. The Pack Memory function executes, and will display a completion message on the LCD when all the memory has been packed. The display will then return to the main Options Menu.

4.5.7. Setting the Real-Time (RT) Clock

Solo has a battery-backed real-time clock that maintains the current date (month, day, year) and time in 24-hour format (hours, minutes). Follow the instructions below to change the real-time clock setting.

- a. Press while viewing the RUN TEST/OPTIONS prompt to enter the Options Menu.
- b. Use the arrow keys to scroll to item 5. `SET RT CLOCK` and press . The current date and time setting appears on the LCD as shown in *Figure 28*.



Figure 28

- c. Use the right and left arrow keys () to move the selection arrows (> <) to the date/time field you wish to modify. Then use the up and down arrow keys () to increment or decrement the selected date/time field.
- d. Press to accept the new clock setting, or press or to return to the main Options Menu without modifying the clock.

4.5.8. Selecting Pressure Units

In the Occlusion Pressure Test, pressure is measured in units of mmHg and another user defined unit; psi, kPa, or bar. To select the user defined unit of measure, follow the instructions below. The default selection is psi.

- a. Press while viewing the RUN TEST/OPTIONS prompt to enter the Options Menu.
- b. Use the arrow keys to scroll to item 6. PRESSURE UNITS and press .
- c. Use the arrow keys () to scroll through the three different pressure units (psi, kPa, bar). Press to select the currently displayed pressure units, or press to return to the main Options Menu without any changing the pressure unit selection.

4.5.9. Configuring the Auto Test

In Auto Test mode, *Solo* will run a Rate+Volume Test followed by an optional Occlusion Pressure Test. The duration of these two tests are configured by setting the Infusion Timer and Occlusion Timer. To set the Infusion Timer and/or Occlusion Timer, follow the instructions below.

- a. Press while viewing the RUN TEST/OPTIONS prompt to enter the Options Menu.
- b. Use the arrow keys to scroll to item 7. AUTO TEST SETUP, and press .
- c. The current Infusion Timer setting will appear on the lower line of the LCD. To keep the current infusion timer setting, press or , and the display advances to the Occlusion Timer setting.

To change the Infusion Timer setting, enter a new timer value using the numeric data keys (secondary functions) on the keypad and press . Note the Infusion Timer can hold a value in the range 10 - 9999 seconds. If a value less than 10 seconds is entered, the timer will be set to a default value of 10 seconds.

INFUTEST SOLO OPERATING MANUAL

- d. The display advances to show the current Occlusion Timer setting on the lower line of the LCD. To keep the current Occlusion Timer value, press or , and the display returns to the Options Menu.

To change the occlusion timer setting, use the up and down arrow keys () to increase or decrease the timer value respectively. Note that the occlusion timer settings are predefined, and must be selected from one of the following discrete timer values: OFF; 1 minute, 2 minutes, 3 minutes, 5 minutes, 10 minutes, 20 minutes. Press to select the currently displayed occlusion timer setting, or press to return to the main Options Menu without changing the Occlusion Timer setting.

4.5.10. Editing the Solo ID

In a particular facility, there may be more than one *Solo*, or a need to identify *Solo* by its control number. To uniquely identify each instrument, an ID field is provided. The field is a 20-character alphanumeric identifier stored in *Solo's* non-volatile memory. The default ID is "-----". To edit the ID, follow the instructions outlined below.

- a. Press while viewing the RUN TEST/OPTIONS prompt to enter the main Options Menu.
- b. Use the arrow keys to scroll to item 8. EDIT SOLO ID and press . The current ID setting will appear on the lower line of the LCD:



Figure 29

To edit the current ID, press . Press or to return to the Options Menu without changing the ID.

- c. Enter a new ID either via the alphanumeric data keys (secondary functions) on the keypad or via the accessory barcode reader and press . Refer to Section 4.2 for barcode reader operation if *Solo* is identified using a barcode label. The new ID is saved, and the display will return to the main Options Menu.

4.5.11. Checking the Battery Status

Follow the instructions below to check the voltage of the internal NiMH battery. If the battery capacity is near “empty”, recharge the battery following the procedure outlined in Section 4.6.

- a. Press while viewing the RUN TEST/OPTIONS prompt to enter the Options Menu.
- b. Use the arrow keys to scroll to item 9. BATTERY STATUS, and press . A bar graph will appear on the LCD (*Figure 30*) showing the battery potential. The E on the bar graph corresponds to “Empty” and the F corresponds to “Full”.

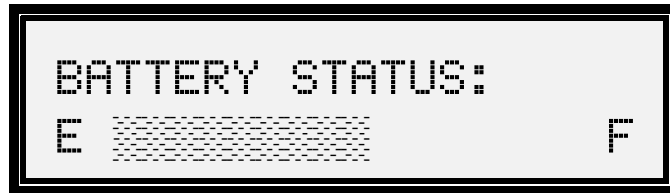

Figure 30

- c. To exit the Battery Status function, press , or to return to the main Options Menu.

4.6 Recharging the Battery

Solo is powered by an internal NiMH battery with sufficient capacity to provide approximately 30 hours of continuous operation. When the battery approaches complete discharge, the display will flash with a Low Battery warning message (Section 6.1).

To recharge the battery, connect the AC adapter supplied with *Solo* to the jack on *Solo's* rear panel, then plug the adapter into a grounded wall outlet. Use only the adapter supplied with *Solo* to recharge the battery. It will require approximately 14 hours to fully recharge the battery. However, with the AC adapter plugged into the unit, normal operation will resume, and *Solo* may be operated while the battery charges in the background.

Note: If the battery is *severely discharged*, it may be necessary to charge the battery for a short period of time before *Solo* will power-up.

5. REMOTE CONTROL

*This chapter describes **Solo's** serial communications features and specifies commands used to request information from **Solo**, or to remotely control its operation.*

5.1 General Description

The RS-232 Port provides an interface for controlling **Solo** remotely using an external device such as a personal computer or automated test system. **Solo** will recognize a predefined set of commands issued to its RS-232 Port allowing the external device to start a test, stop a test, or retrieve test results automatically.

Remote commands allow the creation of simple programs on a personal computer that will automatically perform and document a pump test according to a desired protocol. The command set is also compatible with automated test instrumentation, such as Datrend's ES601Plus or medTester 5000C from Fluke. Refer to the operator's manual for your automated test instrument, especially with regard to port settings, cable wiring, data transmission format and data packet length. The serial protocol of **Solo** is 9600 Baud, 8 Data Bits, No Parity, 1 Stop Bit (**9600, N, 8, 1** - see Section 1.5)

The following sections present **Solo's** remote control command set. When using these commands, it is assumed the user has primed and flushed **Solo** prior to enabling the controlling device, and the controlling device is connected to **Solo** using the appropriate interface cable as described in Section 3.3. If using a program on a personal computer to command **Solo**, allow a delay of at least 100 milliseconds between consecutive remote commands to provide enough time for **Solo** to process and respond to each received command.

An example Visual Basic[®] program illustrating the use of the remote control command set is included on the **DTP Solo** CD-ROM provided with **Solo**. Alternatively, you may download the example program from the Datrend website at www.datrend.com.

5.2 Command Set

There are 6 commands in *Solo's* remote control command set. Each command consists of two upper case ASCII characters followed by a carriage return character (<CR> or \r). *Solo* will respond to remote commands received at the RS-232 Port except when a function in the Options Menu is executing (i.e., View Records, Output Records, etc.) or when data entry is being requested from the user.

If *Solo* receives a valid RS-232 command, it will execute the command, and return either an asterisk character followed by a carriage return (*<CR>) or a packet of data back to the control device depending on the type of command issued. If a command is syntactically incorrect, or not recognized by *Solo*, a question mark character followed by a carriage return (?<CR>) is transmitted back to the controlling device.

5.2.1. Run Flow Test

Syntax: RF<CR>

Description: The Run Flow Test command initiates a Rate+Volume Test.

Returns: (1) ?<CR> Syntax error; Invalid command.
(2) *<CR> Acknowledged, Rate+Volume Test is started.

5.2.2. Run Pressure Test

Description: The Run Pressure Test command starts an Occlusion Pressure Test. This command may also be used while a Rate+Volume Test is in progress to immediately terminate the flow test and start the pressure test. This remote command is equivalent to manually pressing the  key on the keypad while a flow test is in progress.

Syntax: RP<CR>

Returns: (1) ?<CR> Syntax Error; Invalid Command.
(2) *<CR> Acknowledged, Occlusion Pressure Test is started.

5.2.3. Stop Test

Description: The Stop Test command will terminate the test currently in progress and display the test summary on the LCD. This remote command is equivalent to stopping a test manually by pressing the  key.

Syntax: ST<CR>

- Returns:
- (1) ?<CR> Syntax error; Invalid Command.
 - (2) *<CR> Acknowledged, test in progress successfully terminated.

5.2.4. Get Flow Result

Description: The Get Flow Result command retrieves the flow measurement result summary. This command is only recognized while a test summary containing flow data is displayed on the LCD. Since the test result summary appears on the LCD immediately after a test has been terminated, the Get Flow Result command is generally issued after the Stop Test command.

Syntax: GF<CR>

- Returns:
- (1) ?<CR> Syntax error; Invalid Command.
 - (2) A character string with the format:

hh:mm:ss VVVVV ml AAAAA ml/h <CR>

where **hh:mm:ss** is the elapsed time of the test in hours, minutes and seconds, **VVVVV** is the total volume effused, and **AAAAA** is the average flow.

5.2.5. Get Pressure Result

Description: The Get Pressure Result command retrieves the pressure measurement result summary. This command is only recognized while a test summary containing pressure data is displayed on the LCD as described in Section 4.4.5. Since the test result summary appears on the LCD immediately after a test has been terminated, the Get Pressure Test command is generally issued after the Stop Test command.

Syntax: GP<CR>

Returns: (1) ?<CR> Syntax error; Invalid Command; No pressure results available.

(2) A character string with the format:

MAX **PPPP** **uuu** **pppp** mmHg at **mm:ss** <CR>

where **PPPP** is the peak pressure in user defined units, **uuu** are the user defined units (psi, kPa or bar), **pppp** is the peak pressure in mmHg and **mm:ss** is elapsed time at which the peak pressure was detected in minutes and seconds.

5.2.6. Data Download

Description: The Data Download command retrieves all saved Test Records stored in *Solo's* non-volatile memory.

Syntax: DD<CR>

Returns: (1) ?<CR> Syntax error; Invalid command; No Test Records in memory.

(2) An output report containing all Test Records stored in memory in the format shown below. Records are output starting with the most recent.

INFUTEST SOLO OPERATING MANUAL

Datrend Systems Inc.
Infutest Solo S/N IS04120123
Solo ID: -----
Version 1.00

RECORD #: 24
PUMP I.D.: ECN12345A
TEST DATE: 15 Jan 2004
TEST TIME: 10:21
AVG. RATE: 106.4 ml/hr
INF. VOL.: 24.58 ml
INF. TIME: 00:14:33
PEAK OCCL PR: 14.3 psi
739 mmHg
PEAK OCCL PR AT: 02:14

RECORD #: 23
PUMP I.D.: CN00045-9
TEST DATE: 12 Jan 2004
TEST TIME: 08:55
AVG. RATE: 198.7 ml/hr
INF. VOL.: 39.78 ml
INF. TIME: 00:12:01
. . .

RECORD #: 1
PUMP I.D.: ABBOTT PLUM
TEST DATE: 05 Jan 2004
TEST TIME: 15:53
AVG. RATE: 391.0 ml/hr
INF. VOL.: 11.15 ml
INF. TIME: 00:03:25
PEAK OCCL PR: 11.8 psi
604 mmHg
PEAK OCCL PR AT: 01:57

Technician: _____

Date: _____

END OF DATA

Figure 31

INFUTEST SOLO OPERATING MANUAL

Error and Warning Messages

This chapter describes errors and warnings that may be displayed by Solo, and methods of recovery from such error conditions.

6. ERROR & WARNING MESSAGES

There are several error and warning messages that may occur. Some error conditions may be corrected, while others are irreversible. This section details the different error and warning messages, and how to deal with them.

6.1 Low Battery

The Low Battery warning (*Figure 32*) message appears when the internal battery voltage drops below a minimum safe operating level. To clear this warning message, recharge the internal battery following the procedure outlined in Section 4.6.



Figure 32

Note: This message will not display if a pump test is in progress.

6.2 Dead Battery

The Dead Battery error message (*Figure 33*) appears if the internal NiMH battery in *Solo* fully discharges during use. After this error message is displayed on the LCD, the unit will power itself off. To recover from the Dead Battery error, turn the power switch to the OFF position and connect the AC adapter to the unit. Recharge the battery as described in Section 4.6.



Figure 33

Note: If the battery is *severely discharged*, *Solo* may not power up. If this happens, it will be necessary to charge the battery for a short period of time before normal operation is restored.

6.3 Flow Sensor Unprimed

The Flow Sensor Unprimed warning message (*Figure 34*) appears if *Solo* is not primed with water when the unit is powered up. The warning message is cleared upon a key press and normal operation will resume. To avoid this warning message, remember to keep the flow sensor primed between uses (see Section 3.2).



Figure 34

6.4 Calibration Fault

The Calibration Fault error message (*Figure 35*) appears if calibration parameters stored in *Solo's* non-volatile memory have been corrupted. To clear this error message, try restarting *Solo* by powering off, waiting for 15 seconds, and powering on. If the problem persists, contact Datrend Customer Service at 1-800-667-6557 (604-291-7747 outside of North America) or via email at customerservice@datrend.com.



Figure 35

6.5 Pressure Zero Fault

The Pressure Zero Fault error message (*Figure 36*) appears if there is excessive pressure at *Solo's* input when the unit is powered on. To clear this fault message, remove any pressure applied to the input and restart *Solo*.



Figure 36

If *Solo* is left in a partially primed state (e.g. the glass and tubing are filled with sections of air and small columns of water) simply connecting then disconnecting a collection vessel to the O/P may result in enough pressure being applied then stored in the system to cause a fault when the unit is powered on and the self test is performed.

There are two methods for clearing the fault and removing the pressure.

One method is to release the pressure by opening the I/P shut-off valve. This can be accomplished by connecting the appropriate coupling to the I/P shut off valve thus releasing the pressure. The applied coupling may not be connected to an Infusion pump or any other device, it must be open to atmosphere.

INFUTEST SOLO OPERATING MANUAL

The second method is to prime the unit and then remove any connections to the I/P and O/P couplings.

In either case, re-power the unit.

If the problem persists, contact Datrend Customer Service at 1-800-667-6557 (604-291-7747 outside of North America) or via email at customerservice@datrend.com.

6.6 Port Off-line

The Port Off-line error message (*Figure 37* or *Figure 38*) will appear if the RS-232 or USB cable is not properly connected between *Solo* and the peripheral device. Clear this error message by checking all cabling for proper wiring connections (see Section 3.3).



Figure 37



Figure 38

6.7 Download Application Not Running

The Download Application Not Running error message (*Figure 39*) appears if an attempt is made to output Test Records from *Solo* to a PC via USB without *DTP Solo* running on the PC. Make sure *Solo* is properly connected to the PC using a standard USB cable, and that the *DTP Solo* application is running on the PC.

If *DTP Solo* is running, and this error message still appears, try restarting the program, or unplug and re-plug the USB cable into the PC. Remember, the *DTP Solo* application will not recognize the attached device if *Solo* is executing an Options Menu function (i.e. View Records, Output Records, etc.) or requesting a Pump ID from the user.



Figure 39

6.8 Memory Full

The Memory Full error message (*Figure 40*) appears if an attempt to save test results is made and the non-volatile memory is full. *Solo* is capable of storing up to 123 Test Records. Press to return to the test result summary. To free memory space for future save operations, execute the Delete Record function (see Section 4.5.2) and / or the Pack Memory function (see Section 4.5.6), or the Erase Memory function (see Section 4.5.5).

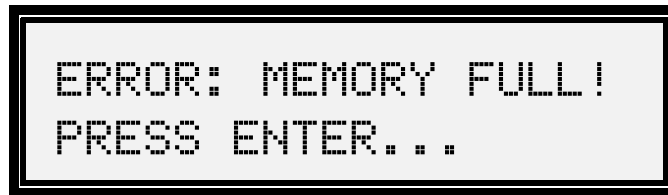

Figure 40

6.9 Injection Failure

The Injection Failure error message (*Figure 41*) appears during a flow test if there is an air bubble residing in the fluid pathway, or if there is a fault with the internal injector valve. Try re-priming and flushing *Solo* as described in Section 3.2, and then attempt to start a Rate+Volume Test. If the Injection Failure error message persists, contact Datrend Customer Service at 1-800-667-6557 (604-291-7747 outside of North America) or via email at customerservice@datrend.com.



Figure 41

6.10 Over-Pressure Alarm

The Over-Pressure Alarm (*Figure 42*) is a result of excessive pressure (> 50 PSI) applied to the *Solo* input. If the input pressure exceeds the maximum allowable pressure of 50 PSI, the pressure test in progress will automatically stop and the Over-Pressure Alarm is displayed. Pressing the key will clear this error message to display the test result summary.



Figure 42

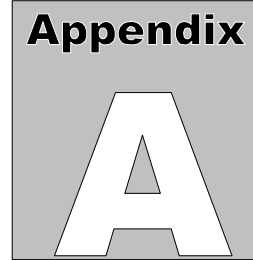

APPENDIX A. BACK PRESSURE TESTING

The user may apply a back pressure to the infusion device under test to oppose the flow from the device. Back pressure of up to 300 mmHg may be applied during the Rate+Volume Test at the output of *Solo*.

This appendix describes the apparatus and provides instructions for testing an infusion device with a pneumatically-applied back pressure. The test apparatus and method discussed are similar to those recommended by the **Association for the Advancement of Medical Instrumentation (AAMI)** in their proposed standard for infusion devices.

Connect the apparatus shown in *Figure 43* to the output of *Solo* as illustrated. The flask should have a large internal volume (1 to 2 litres) so that the fluid level within the flask does not change substantially during the test. The components and all seals should be capable of withstanding the maximum pressure applied to the system.

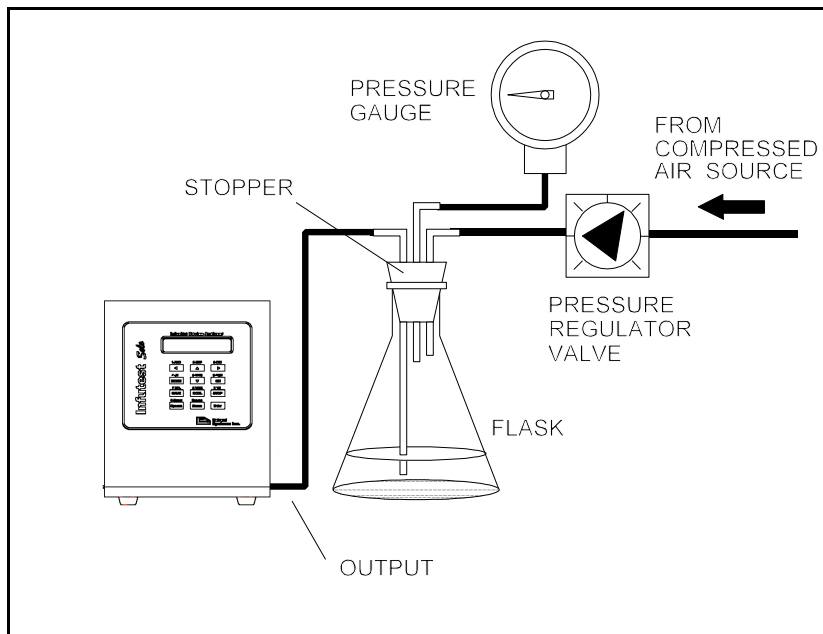

Figure 43: Apparatus for Applying Back Pressure

INFUTEST SOLO OPERATING MANUAL

Alternatively, a syringe bulb may be used to pressurize the flask instead of the compressed air source and regulator valve shown in *Figure 43*. This approach, although simple, has the disadvantage in that the back pressure is unregulated. If air leaks are present within the system, or if the water level within the flask changes substantially, the back pressure will be affected and the test results may be invalid.

To perform a Rate+Volume Test with an applied back pressure:

- a. **Power up *Solo* with NO PRESSURE applied to the output.** During its power-on self-test, *Solo* will auto-zero the internal pressure sensor.
- b. If a back pressure is detected at the time of power-up, *Solo* will produce an alarm. Refer to Section 6 if an alarm condition arises.
- c. While viewing the RUN TEST/OPTIONS prompt, the fluid system of *Figure A-1* may be primed with water as described in Section 3.2 and the flask pressurized up to a **maximum of 300 mmHg** before starting the test.

Under no circumstances should a vacuum be applied to the output as this may damage the internal pressure sensor.

- d. Water may be pumped out of the flask into *Solo's* output during pressurization of the apparatus. If this happens, reprime *Solo* once the apparatus has been pressurized so that the tubing connecting the output to the flask is completely filled with water.
- e. Prepare the device under test, then set up and start a Rate+Volume Test (Section 4.4). Note that the back pressure is not displayed by *Solo* or saved as part of a Test Record.
- f. The back pressure should not be allowed to change for the duration of the test. IV tubing is compliant, and an increase in back pressure may cause a drop in measured flow and volume simply because the IV tubing is being stretched by the increased pressure in the system. Variations in device performance may therefore be more an effect of the tubing than of the device itself.

APPENDIX B. OPERATIONAL OVERVIEW

B.1 General Description

Figure 44 shows a block diagram of *Solo*. During a flow test, test fluid enters the unit via its fluid input, passes through the fluid channel, drains into a collection tank and eventually exits via the fluid output. As fluid passes through the internal fluid channel, a flow sensor and injector valve (INJ) co-ordinate to measure flow rate and effused volume. During an Occlusion Pressure Test, fluid is blocked from passing through the internal fluid channel using an occluder valve (OCV). Occlusion pressure is then measured with a pressure sensor connected at the fluid input via a tee.

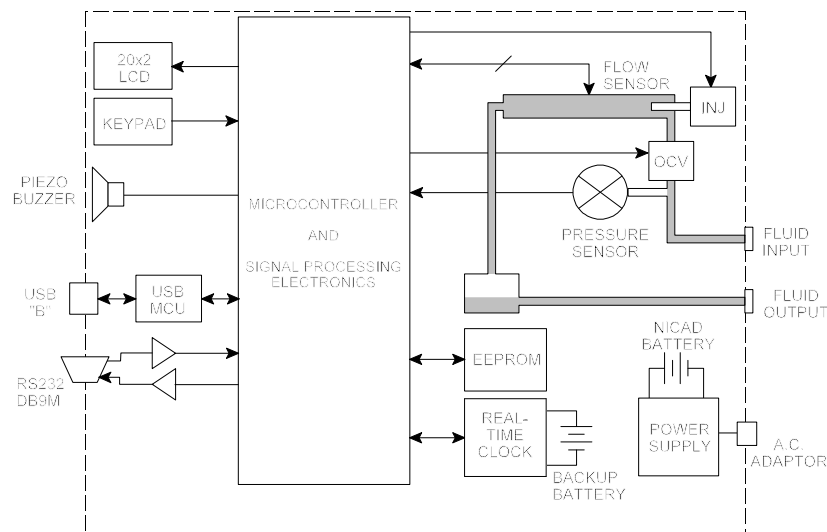

Figure 44: Infutest Solo block diagram

Analog signals from both the flow and pressure sensors are converted to digital, and further processed by an 8-bit microcontroller. The microcontroller operates the LCD, keypad, piezo-buzzer and RS-232 interface, controls test execution, and interfaces to the USB port through a USB controller.

INFUTEST SOLO OPERATING MANUAL

Calibration data for the flow and pressure sensors are stored in the EEPROM memory of *Figure 44*. Calibration of *Solo* is completely software based - there are no manual adjustments or controls inside the unit.

B.2 Flow Measurement System

Figure 45 diagrams *Solo's* flow sensor consisting of an occluder valve, injector valve, 21-gauge needle, glass tube, and collection reservoir. The sensor's glass tube is elevated above the fluid inlet and outlet ports. With the system primed, the nominal 6" column of water leading from the output of the glass tube into the collection reservoir develops a pneumatic pressure on the air contained inside the enclosed reservoir. This pressure is transmitted to the input of the injector valve through tubing. When the normally-closed injector valve opens, it introduces an air bubble approximately 1 cm in length into the test fluid through the needle located at the sensor input. During bubble injection, the occluder valve blocks incoming fluid flow.

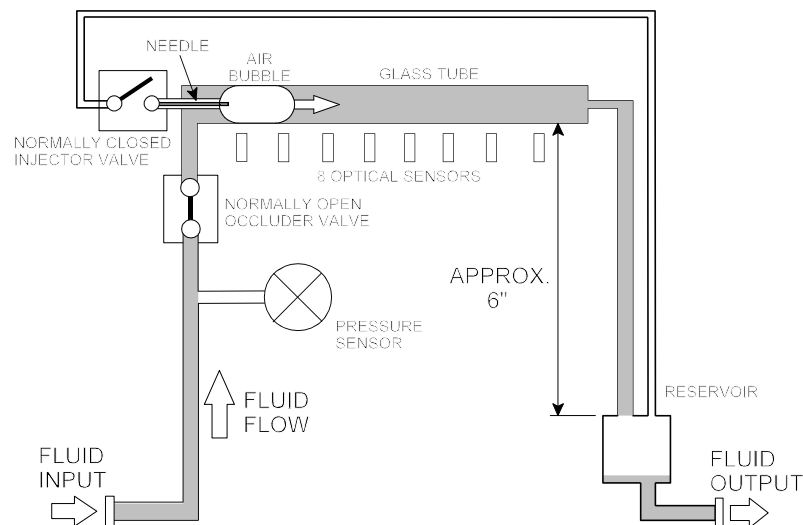

Figure 45

Fluid entering the flow sensor pushes the injected bubble through the glass capillary tube. The tube has an end-to-end volume of approximately 1.2 ml. An array of 8 optical sensors located along the glass tube continuously tracks the bubble position for flow measurement. Every time the bubble crosses the 8th optical sensor, a new bubble is injected into the glass tube.

INFUTEST SOLO OPERATING MANUAL

Volume of the glass capillary tube between adjacent optical sensors is calibrated at the factory to within ± 0.0000052 ml using a precision microsyringe dispensing system. These volume calibrations along with other flow sensor and pressure sensor calibrations are programmed into the *Solo's* EEPROM memory.

Flow measurement is based on a transit time principle. As described, volume of the glass tube between optical sensors is known precisely. Flow is derived by measuring the time required for the bubble to cross these calibrated volumes. Volume is derived by summing the calibrated volumes incrementally as the bubble crosses them.

Note that the collection tank in the pneumatic feedback system is mostly filled with air. Therefore, fluid draining from the Fluid Output is poorly correlated with fluid entering the input.

B.3 Pressure Measurement System

During the Occlusion Pressure Test, the occluder valve shown in *Figure 45* energizes and blocks fluid flow downstream of the pressure transducer. The pressure transducer senses the pressure developed by the infusion device under test, and resulting pressure measurements are displayed on the LCD.

INFUTEST SOLO OPERATING MANUAL

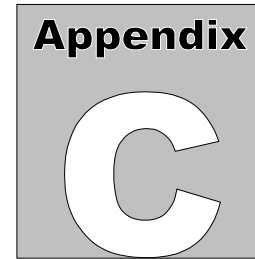

APPENDIX C. CALIBRATION

C.1 Annual Calibration

Calibration of *Solo* by a Datrend Authorized Service facility is recommended on an *annual* basis, and is *required* to extend the product warranty. The basic one (1) year warranty can be extended to a maximum of five (5) years provided that annual calibration is performed by a Datrend Authorized Service Center on an *annual* basis.

Refer to the Calibration Decal applied to the rear panel of the unit to determine calibration status of your *Solo*.

Solo may only be **CALIBRATED** with specialized equipment and software found at Datrend authorized service facilities. This equipment allows proper adjustment of the internal electronics of the instrument.

Independent service centers *may* be able to perform a performance **VERIFICATION**; however, they will NOT be able to perform repairs or adjustments to your *Solo*.

When calibration is due, contact Datrend Customer Service at 1-800-667-6557 (604-291-7747 outside of North America) about the authorized service facility nearest your location and to obtain an RMA number.

Datrend Systems Inc.
#130 - 4020 Viking Way
Richmond, BC • CANADA • V6V 2L4
Tel 604.291.7747 or 800.667.6557 • Fax 604.294.2355
e-mail customerservice@datrend.com
www.datrend.com

C.2 Calibration Verification

C.2.1 Pressure Accuracy Verification - Field Test

Solo's pressure measurement system may be verified in the field by running an Occlusion Pressure Test with an external pressure gauge connected via a tee to the input. Validity of the pressure calibration verification will be dependant on the accuracy and traceability of the external gauge used.

C.2.2 Flow Accuracy Verification - Field Test

The flow measurement system CANNOT be verified in the field using infusion devices intended for medical applications. Such device lack the stability and repeatability required for checking calibration.
The flow measurement system CANNOT be verified in the field using measuring devices connected to the Output.

The flow measuring system may be verified using a precision syringe pump of laboratory grade which has itself been calibrated using a gravimetric test protocol and apparatus similar to that defined in IEC 601-2-24 Part 2, or equivalently, ANSI Standard ID-26. We recommend Harvard Apparatus model 22 or model 44 with a precision-ground glass syringe or glass microsyringe having the minimum volume necessary for the verification, depending on the verification rates of interest (Harvard Apparatus USA, Holliston MASS, (800)-272-2775; ENGLAND Edenbridge, Kent, 44-1732-864001; www.harvardapparatus.com). For verification rates in the range 50 to 200 ml/hr, B-D Yale #2313 (precision 20 cc) is recommended.

If the test pump is a Harvard model 22 equipped with B-D Yale #2313, the test pump should be tested gravimetrically at 50 ml/hr and 200 ml/hr prior to each verification run on *Solo*. The pump should be allowed to dispense 1 ml at the selected rate before any test measurement is started. Use an analytical balance to measure the mass of distilled water effused from the test pump over 10 minutes at 50 ml/hr and over 4 minutes at 200 ml/hr. Calculate the average rate in ml/hr by dividing the mass by the specific gravity (0.9973 gm/ml at 24°C), and then by the test time. Compare this result to *Solo's* Average Flow from a Rate+Volume Test of 10 minute (50 ml/hr) or 4 minute (200 ml/hr) duration. Three runs, consisting of a gravimetric measurement followed by the *Solo* Rate+Volume Test, should be conducted to obtain repeatability of both the standard (gravimetric) and *Solo*.